

Before purchasing tools, timber and materials, read every step thoroughly then talk to one of our experts

Step 1: Before You Start

Draw your Pergola floor plan and elevations on graph paper to an easily convertible scale, e.g. 1 metre equals 2 graph squares. Draw your support posts (uprights) at grid line intersections to make things easier.

Don't forget to allow for the overhang of rafters.

Most local Councils require that plans are submitted for approval so it might be prudent to check with them first. While you're at it, check the locations of any underground utilities that you may encounter when digging your post holes.

Step 2: Choosing The Spot

Depending on its application, as a garden courtyard, carport, barbecue area or outdoor patio, think about the location.

Do you need shade from the sun, more privacy, or protection from the wind? Do you want proximity to a house doorway, etc? Do you want morning sun or afternoon sun? Or shade?

Your Pergola should be positioned to make the most of the winter sun and provide protection from summer sun.

Once you've weighed these questions up, you can choose a patio style which attaches to your home, or garden style which is free standing.

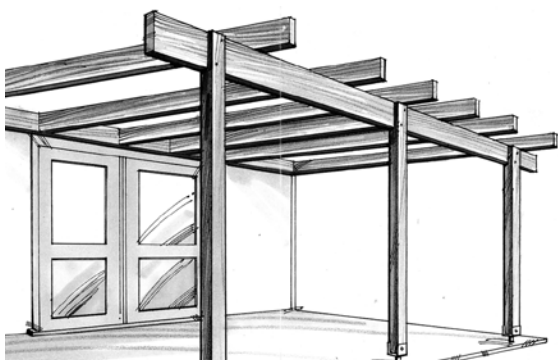

Step 3: Choosing Tools

You'll need a claw hammer, spanner or adjustable wrench, screwdriver, shovel, hand saw or circular saw, electric drill, tape measure, spirit level, pencil, builder's line and marker pegs.



Step 4: Choosing Materials

The types of timbers that are suitable for your pergola are hardwoods, treated pine or cypress pine. Determine the correct sizes and lengths (based on your plan) of posts, beams and rafters. You'll also need concrete mix and some timber off-cuts to use as temporary braces during construction.

The majority of pergolas are made using treated pine. Treated pine timber should have an H4 rating for on, or below ground, application and an H3 rating for above ground.

This timber is treated with compounds of copper, chromium and arsenic, termed CCA. When using this material:

- Wear gloves and dust masks when sawing.
- Any cut or sawn surface of this material will need resealing to ensure its effectiveness in resisting attack.
- Dispose of any off cuts by burying them. Don't burn them as the smoke and ash are toxic.

Nails should be hot-dipped galvanised, to ensure maximum resistance to corrosion and also to reduce marking of the timber from rust stains. Bolts, nuts, washers, coach screws or any other fixing device should also be hot-dipped galvanised, to maximise the longevity of the pergola. You may wish to use galvanised post footings instead of in-ground posts and galvanised framing anchors, angle brackets, universal brackets and corner brackets will be handy.

You should also buy your paints or stains at this stage too. If you intend to finish your pergola in a timber stain colour you should apply a coat of water repellent preservative on all surfaces, followed by one coat of stain as soon as you get the timber home. If you intend painting, give all surfaces a coat of oil base wood primer followed by the first coat of paint. As you build, it's important to seal all cut ends with stain or primer prior to fixing them in position so no moisture or water will affect them.

Step 5: Mark The Site

Prepare the site using your builder's line, tape measure and line pegs to mark out your ground plan, ensuring that it's both parallel and square.

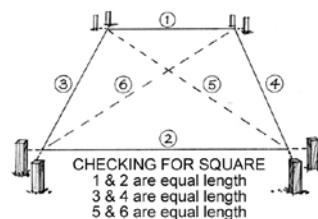

Use more line pegs to indicate the centre of holes to be dug for the upright posts. The holes should then be dug at least 450mm deep by 300mm square for an average size pergola. Hiring a post-hole digger might save you a lot of hard work here.

Place a brick or gravel in the bottom of each hole. Use a spirit level to double check that the temporarily braced uprights (using off-cuts) are vertical before adding concrete to the holes.

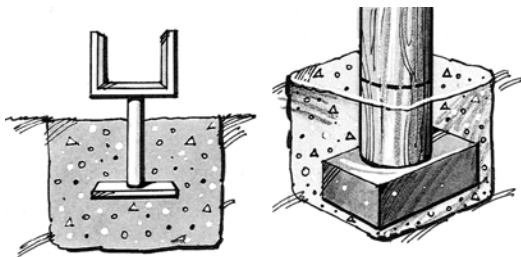

Alternatively use post supports which are set into concrete. Use a string-line to make sure they all line up, and they're at the same height. These supports are usually pre-drilled so that the posts can be attached later with coach screws.

To allow for drainage, don't put the posts flush with the bottom of the brackets. (This is where you will need an extra pair of hands to hold the posts upright while you drill and screw them into place.)

You should wait seven days to allow normal concrete to settle and harden or you could use a rapid set concrete that hardens in about 30 minutes.

Step 6: Affix Beams And Rafters

With the concrete set, you can attach the supporting cross beams, ready to take the rafters. The top of each upright should be halved to take the beam ready to support the rafters. Then drill and bolt these beams to the upright posts. Cut

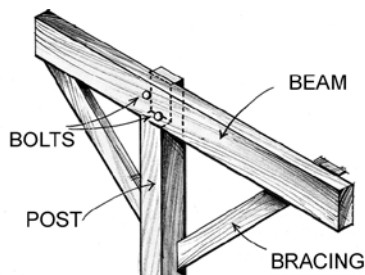

the top of the upright just a fraction lower than the beam to permit water runoff.

Galvanised framing anchors, angle brackets, universal brackets and corner brackets start to make the job much easier and neater from this point on, but you can skew nail if you wish.

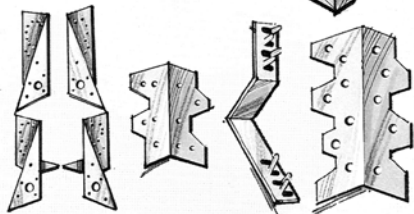
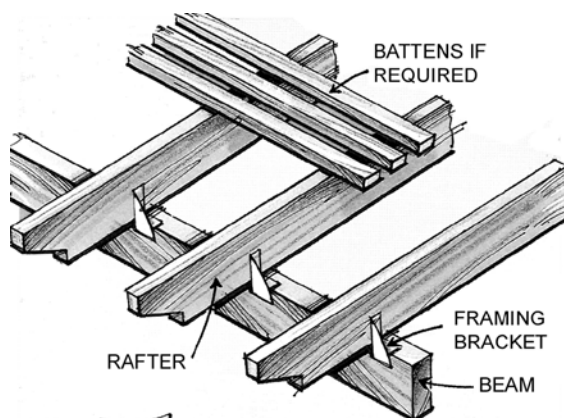

Lay your rafters across the beams, measure equal distances, mark and fix, using galvanised framing anchors.

Fixing To A Wall

You'll need a board or wall plate to attach the rafters to. This is fixed to the walls of brick homes using masonry anchors. With a weatherboard home use coach screws, ensuring they are fixed through weatherboards into wall studs. The weatherboards alone are not strong enough to support the pergola and the weight of the rafters.

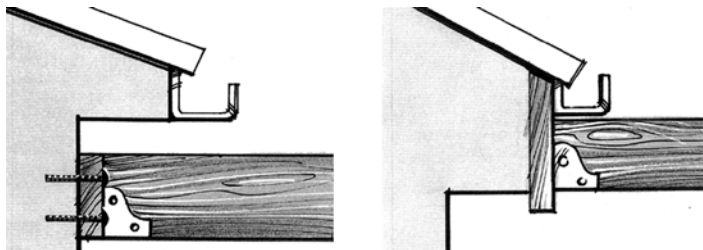

A beam the same size as the wall plate should be bolted to the upright posts. Make the height of the beam a fraction lower than the wall plate. This allows for water run-off

The rafters can now be attached to the beam and wall plate. They can be skew nailed, but a neater, squarer job is ensured using galvanised framing anchors. Either way, pre-drill each rafter to avoid splitting the timber.

Step 7: Finishing Off

Apart from appearance, finishing with paint or stain preserves the life of your new pergola. If you have already prepared your timbers as per Step 4, you can now apply the final coats of paint or stain.

Pergola Hints

- Measure twice ... cut once. Double check all measurements and markings before you cut any piece of timber.
- Use shade cloth, battens or fibreglass sheeting to provide shade from your pergola.
- A free-standing pergola can also be easily turned into a carport by adding a roof and stormwater run-off.
- Balustrades give a pergola a sense of intimacy. Use either trellis or some other form of balustrade between the pergola posts and leave one or two areas open for access.

Disclaimer:

The Retailer which supplies this information (which includes the authors of this advice and the owner, proprietors and employees) is not responsible for the results of any actions taken on the basis of this information nor for any error or omission in this advice. The Retailer expressly disclaims all and any liability and responsibility in respect of anything done consequent on the whole or any part of this advice.

The recipient of this advice is advised to call a qualified tradesperson such as an electrician, plumber or carpenter where expert services are required.

Building permits may be required and there may be legal requirements or statutory bodies that need to be followed in the implementation of this advice. All such permits and requirements are the responsibility of the recipient of this advice.

© Copyright Hardware & Building Traders Pty Limited

With Compliments